

3. Compare and Contrast, Isaiah 46 Elder Parminder Biant Reunion Island, March 3, 2019

<https://www.youtube.com/watch?v=3NU7JQaMrYo&list=PLK-X0FNKqBgn0WnSYqzahDh8qZxAf5uGs&index=10>

Signs, Seals, and Marks

In the last presentation I received a question, which I will just answer briefly. Question: “What proof is there that the Sabbath is the ‘Seal of God,’ because the Bible speaks of ‘Signs’ and not about the ‘Seal’?”

If you turn to your Bibles, you can go to different places to see this. We will go to Exodus 31:13. *“Speak thou also unto the children of Israel, saying, Verily my sabbaths ye shall keep: for it [is] a sign between me and you throughout your generations; that [ye] may know that I [am] the LORD that doth sanctify you.”* So, in this passage it says that the Sabbath (which they are required to keep) is a ‘Sign’ between them and God.

Go to Ezekiel 20:12. *“Moreover also I gave them my sabbaths, to be a sign between me and them, that they might know that I [am] the LORD that sanctify them.”* So, in both of these passages it talks about the Sabbath being a sign. If you remember in an earlier presentation, I said that at a very simple level the Sabbath was a ‘Seal.’

I took us to Ezekiel 9:4. *“And the LORD said unto him, Go through the midst of the city, through the midst of Jerusalem, and set a mark upon the foreheads of the men that sigh and that cry for all the abominations that be done in the midst thereof.”* It talks about setting a mark upon the foreheads of Gods people who are faithful.

I took us to another passage, Revelation 9:4. *“And it was commanded them that they should not hurt the grass of the earth, neither any green thing, neither any tree; but only those men which have not the seal of God in their foreheads.”* In this passage it talks contextually about a punishment that is coming upon the world by this fifth trumpet; and in the context of this punishment it says, don’t punish those people who have the ‘Seal of God’ in their foreheads. I am saying that this ‘Seal’ in Revelation 9 is the same as the ‘Mark’ in Ezekiel 9. It is placed in the same location and it acts as a form of safety or protection. In Revelation 9:4 it says don’t hurt those people that have this seal. And in Ezekiel 9 the placing of the ‘Mark’ protects those people, so they are not killed.

And in fact, in the context of our study about the destruction of Jerusalem in its three phases (see Boardwork 5:12) when we spoke about a remanent (and we went to Isaiah 6:13 to show that, and we went to Matthew 24:15, 16 to show a remanent), that remanent is being identified in Ezekiel 9. It is those people who are going to be saved and not destroyed in the destruction of Jerusalem.

Boardwork 5:12

Siege		Siege	
Z		(70)	
Destruction		Destruction	
Jerusalem		Jerusalem	
J1	+	J2	= J3
L/N		L/N	Spirit

Isaiah 6:13 *“But yet in it [shall be] a tenth, and [it] shall return, and shall be eaten: as a teil tree, and as an oak, whose substance [is] in them, when they cast [their leaves: so] the holy seed [shall be] the substance thereof.”*

Matthew 24:15, 16 *“15 When ye therefore shall see the abomination of desolation, spoken of by Daniel the prophet, stand in the holy place, (whoso readeth, let him understand:) 16 Then let them which be in Judaea flee into the mountains:”*

I am sure most of you have read Ezekiel 9; it is a common passage that conservative Christians read and have opinions on. But if you go through the chapter and when it says in verse 5 to smite everyone, this smiting is the destruction of Jerusalem during the time of Nebuchadnezzar. So, I am saying the ‘Mark’ in Ezekiel is the same as the ‘Seal’ in Revelation.

Just a note to refer us back to a contextually relevant passage. Ezekiel 9 follows chapter 8; in Ezekiel 9 people are marked who are ‘good,’ who are obedient to God. I’m sure that you would all agree that that is the definition of being ‘good.’ The people who don’t receive a ‘Mark’ (because they are doing wrong), what’s going to happen to them? They are going to be killed; it says “smite” them. If the parents are sinning their children who are under age received the same punishments as their parents. It says it clearly in this passage that everyone is held guilty except those who are consciously not doing wrong. So, if you go to chapter 8 it tells you what the wrong things that God’s Church are doing. If you have subtitles in your Bible, what’s the subtitle for chapter 8? It says something like “Idoltrous worship” or “Abomination.”

In Chapter 9, it will say something about “Judgement.” So, the judgement is coming in response to the abomination. The people who receive the ‘Mark’ are the ones who are not doing the abominations. So, what are the abominations that they are doing? If you start counting in chapter 8, how many abominations are God’s Church doing? You will find that it is four. We have seen how this number four keeps coming up over and over again.

Ezekiel 8:5 marks the first abomination. *“Then said he unto me, Son of man, lift up thine eyes now the way toward the north. So I lifted up mine eyes the way toward the north, and behold northward at the gate of the altar this image of jealousy in the entry.”* They have created an image or copy of ‘Jealousy.’ In 8:6 it says it’s an abomination.

Ezekiel 8:6 *“He said furthermore unto me, Son of man, seest thou what they do? [even] the great abominations that the house of Israel committeth here, that I should go far off from my sanctuary? but turn thee yet again, [and] thou shalt see greater abominations.”* At the end of 8:6 it says, I’ll show you “greater abominations.” From 8:7 on he explains this, and then 8:10 it begins to explain the second abomination that they are doing.

Ezekiel 8:10 *“So I went in and saw; and behold every form of creeping things, and abominable beasts, and all the idols of the house of Israel, portrayed upon the wall round about.”* They go into a room and on the walls is painted all these idols.

Ezekiel 8:11 *“And there stood before them seventy men of the ancients of the house of Israel, and in the midst of them stood Jaazaniah the son of Shaphan, with every man his censer in his hand; and a thick cloud of incense went up.”* And 8:11 says, there were seventy ancient men; and those ancient men are the leaders. The leadership of the church has gone to these secret chambers and they are offering incense to these idols that are painted on the walls.

Ezekiel 8:13 *“He said also unto me, Turn thee yet again, [and] thou shalt see greater abominations that they do.”* Moving onto 8:13 it says, I’ll show you greater abominations. The third one is in 8:14.

Ezekiel 8:14 *“Then he brought me to the door of the gate of the LORD’S house which [was] toward the north; and, behold, there sat women weeping for Tammuz.”* There are women who are crying to Tammuz. Tammuz is a false idol, that is a false Christ. And it is not a coincidence that they are looking toward the North. All of these three abominations have symbology attached to them. The women, the weeping, the North, all of these have symbolic significance. We are not addressing that here, but in 8:16 you see the culmination or the climax of this apostacy. We will read that. As we are reading think to yourself, what is the final and worst apostacy that God’s Church can do.

Ezekiel 8:16 *“And he brought me into the inner court of the LORD’S house, and, behold, at the door of the temple of the LORD, between the porch and the altar, [were] about five and twenty men, with their backs toward the temple of the LORD, and their faces toward the east; and they worshipped the sun toward the east.”* Before I say anything about this passage, hopefully you noted where these people are standing. It says they are standing between the porch and the altar. This place is a place of significance in Bible prophecy; it is introduced in the book of Joel and the book of Matthew. If you are familiar with the Matthew 23 and Jesus is rebuking the church leadership, that argument is happening on the steps of the temple. This is the place where they kill prophets or the messengers of God. It says that they had their back away from the temple; and where are they looking? To the East. And who or what are they bowing down to? The sun. This is sun worship; this is Sunday worship. What’s being addressed here is the day you worship God. And it is the final sin that God’s Church does before He destroys them. So, part of the answer to the question (when people ask about the connection between the Sabbath and the ‘Seal’) is that the ‘Seal’ in Revelation 9 is the ‘Mark’ in Ezekiel 9; and that ‘Mark’ is placed upon people who don’t bow down to the sun. So, there is a strong Biblical argument to show that the ‘Seal of God’ is connected to the Sabbath. I’ll give you some Spirit of Prophecy quotes.

Remember when we spoke about the 'Mark of the Beast' and the 'Seal of God?' I said that if you put Satan here on one side of the line and Christ here on the other side (see Boardwork 17:17), and you had the 'Mark of the Beast' under Satan and the 'Seal of God' under Christ, then you would have the 'Kingdom of Satan' and the 'Kingdom of Heaven' respectively; because this is 'Comparing and Contrasting' the two. A word that accurately portrays this is called juxtapositioning.

Boardwork 17:17

Satan	Christ
Mark of the Beast	Seal of God
Kingdom of Satan	Kingdom of Heaven

I'll show you what juxtapositioning is. Here is a person (see boardwork 18:02); is this person big or small? How do you know? Let me ask you another question; now is the person big or small (see boardwork 18:18)? Now the person is big. So, the only way you know something is by putting this person next to something. You have to compare them to something.

Boardwork 18:02



Boardwork 18:18



Now when a say a word, you shout out the comparison to me.

Hot : Cold

Strong : Weak

Now if I drew a picture of this person with a mountain (see boardwork 19:04), who is bigger, the person or the mountain? The mountain is, but you cannot compare them. Because you all know, because you live in a three-dimensional world that this person is 5 kilometres in front of the mountain; but the picture doesn't show that. But you can conceptualize it because you live in a 'Natural' world. What we seem to be unable

to do is conceptualize the 'Spiritual' world; and this is what God is trying to teach us through the study of His Word to become familiar with the Spiritual Realm. The only way you can compare this man and the mountain is by bringing them together; and if we did that, this man would look like a small dot next to the mountain. That's how you would compare the two.

Boardwork 19:04

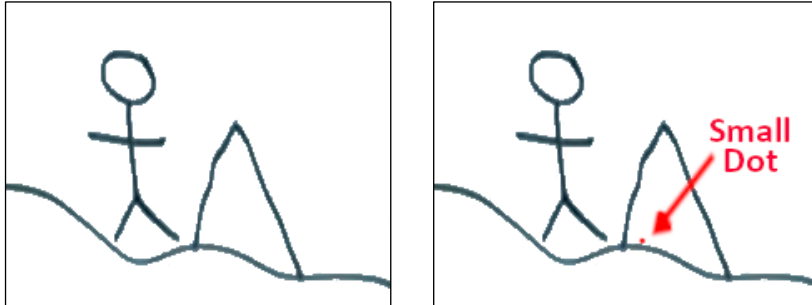

So, I am saying, when you take Christ's Kingdom and Satan's Kingdom, you need to compare them and contrast the differences. This is how Ellen White puts it, this quote is in *Testimonies to the Church* volume eight, page 117. This is in connection with the 'Seal' (because that is the question). What she is going to do is compare these two kingdoms in the same way that I did before. She says, "*The sign, or seal, of God is revealed in the observance of the seventh-day Sabbath...*" Then she says, "*The mark of the beast is the opposite of this...*" So, whatever the 'Seal' is, the 'Mark of the Beast' is the opposite. She says that "*The mark of the beast is the opposite of this--the observance of the first day of the week.*" So, what is the 'Mark of the Beast' according to this definition? The 'Mark of the Beast' is observing the first day of the week; Sunday. Observing means recognizing it as something special. This is the opposite. So, what would be the opposite of the 'Mark of the Beast?' It's the 'Sign' or 'Seal' (that's what she said). Because the opposite of Sunday, is what? Sabbath.

People get hung up on the word 'Sign.' I used the word 'Seal' earlier. I said 'Seal;' the Bible says 'Sign.' How does Ellen White open this paragraph? She says, "*The sign, or seal.*" If I said the 'Sign' or 'Seal,' what would that mean? What's the grammar of that? It means 'Sign' and 'Seal' are interchangeable. So, you can either call it the 'Sign' or the 'Seal.' So she says that the 'Sign' of God is seen when you keep Sabbath, or the 'Seal of God' is seen when you keep Sabbath. The opposite, the 'Mark of the Beast,' is seen when you keep Sunday.

I'll read another passage to you. This is taken from the *Great Controversy* 640.1. We will read the first two sentences. "*The enemies of God's law, from the ministers down to the least among them, have a new conception of truth and duty. Too late they see that the Sabbath of the fourth commandment is the seal of the living God.*" So, the last sentence that we just read says that it's too late now, but they acknowledge and recognize that the Sabbath is the 'Seal' of the Living God. So, Ellen White directly says that the Sabbath is the 'Seal.' The Bible says that it's a 'Sign.' Ellen White 'Sign' and 'Seal' are interchangeable terms.

Parables would show you that you can compare the 'Mark of the Beast,' because it's the opposite of the 'Seal of God.' You could call it the 'Mark of the Beast' and the 'Mark of God.'

In Ezekiel 9, the people who receive the 'Mark of God' are those who are not bowing to the sun. Who are they bowing to then? They must have their backs to the sun worshiping God in His temple. If you 'Compare & Contrast,' you either worship on Sunday (the 'Sun' day, which is the day of the sun), or Sabbath (the day of God). That's what the contrast is.

It wasn't my intention to make a big issue about this, but only those people who worship God on the Sabbath can receive this 'Seal' or 'sign.' Let me read another passage; this is from *Manuscript Release* volume 10 (10MR 252.1). "... Just as soon as the people of God are sealed in their foreheads..." It mentions the 'Seal' again, and it tells you where the 'Seal' is going to be placed (in the forehead). Revelation 9; Ezekiel 9. She then goes on to say, "it is not any seal or mark that can be seen..." Whether you call it a 'Seal,' a 'Mark,' or a 'Sign,' it cannot be seen by human beings. If it cannot be seen by a human being, that means it cannot be placed by a human being. She tells you what it is; she says this "seal or mark" is "... a settling into the truth, both intellectually and spiritually..." And she says, just as soon as that work is completed, then God's people will be prepared for the shaking. "The work in Battle Creek is after the same order. The leaders in the sanitarium have mingled with unbelievers, admitting them to their councils, more or less, but it is like going to work with their eyes shut. They lack the discernment to see what is going to break upon us at any time. There is a spirit of desperation, of war and bloodshed, and that spirit will increase until the very close of time. Just as soon as the people of God are sealed in their foreheads--it is not any seal or mark that can be seen, but a settling into the truth, both intellectually and spiritually, so they cannot be moved--just as soon as God's people are sealed and prepared for the **shaking**, it will come. Indeed, it has begun already. The judgments of God are now upon the land, to give us warning, that we may know what is coming." {10MR 252.1} So, what we can see (the summary of all of that), she talks about a shaking; she says the shaking is the judgement of God. The judgement of God is the seven plagues. She says the plagues won't come until God's people are 'Sealed.' That work of 'Sealing' is complete by the time you get to Daniel 12:1.

Boardwork 31:33

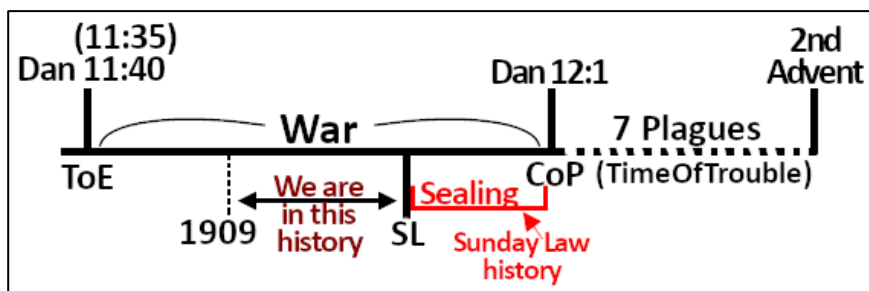

The 'Sealing' occurs in this period here (see boardwork 31:33), which we call the Sunday Law history. That's why the 'Seal' is connect with the Sabbath. And, as this is a 'Seal' or 'Mark' that no one can see (because no one can place it upon you, except Angels of God), the opposite of that would be the 'Mark of the Beast.' No one is going to bring you to a facility and stamp something into your forehead or tattoo you or inject a microchip into your forehead. These are false concepts of 'End Time' prophecy. The 'Mark of the Beast' is your personal willing acceptance, under duress (pressure) from the government and the church, to comply with their will. They will apply pressure to you; Revelation 13. You cannot buy or sell unless you acknowledge Sunday as the 'Day of Rest.'

Hopefully that has answered the question about the Sabbath and the 'Seal' and the relationship between the two. There are many other Spirit of Prophecy quotes that address this subject, it is not just the one's read to you; there are others.

Jerusalem Destroyed 1 + Jerusalem Destroyed 2 = Jerusalem Destroyed 3

At the end of our last presentation, we had drawn a timeline that spoke about the history of God's Church, Ancient Israel. It began at the history of Moses with the twelve tribes, it went through the period of the Judges, and then the period of the Kings beginning with Saul, David, and Solomon. After the death of Solomon (because of his sins) God divided the kingdom. He gave Solomon's son two tribes; his son was Rehoboam. Another leader was raised up by God called Jeroboam, and he led the ten tribes. As soon as Jeroboam had done that work (to begin to lead those ten Northern tribes), he began to commit apostasy; and very quickly the ten tribes were fighting and rebelling against God. Every single one of their kings was evil. Finally, their cup was full (their cup of sin). And it ended in the reign of Hoshea when the Assyrians came to destroy their nation.

Go to Joel 1:2. "Hear this, ye old men, and give ear, all ye inhabitants of the land. Hath this been in your days, or even in the days of your fathers?" It says, "Hath this been in your days..." Now the thing that has just happened is this event here (see boardwork 37:17); it's the destruction of these ten tribes.

Boardwork 37:17

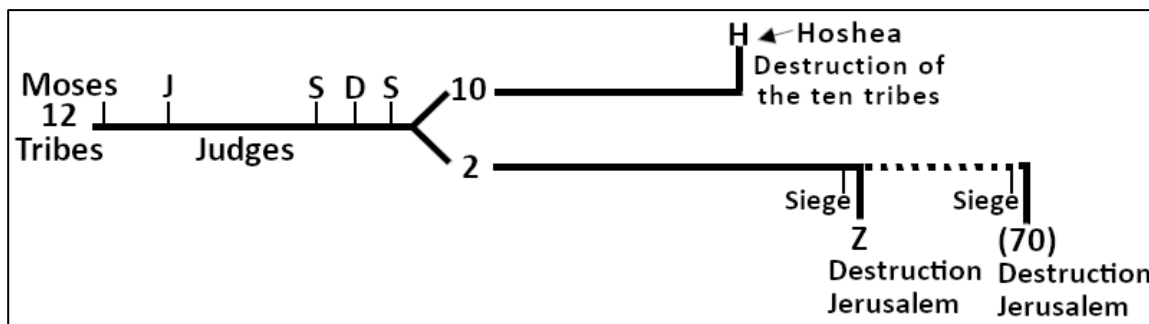

Let's go to another passage; 2 Kings 18:9-12. "9 And it came to pass in the fourth year of king Hezekiah, which [was] the seventh year of Hoshea son of Elah king of Israel, [that] Shalmaneser king of Assyria came up against Samaria, and besieged it. 10 And at the end of three years they took it: [even] in the sixth year of Hezekiah, that [is] the ninth year of Hoshea king of Israel, Samaria was taken. 11 And the king of Assyria did carry away Israel unto Assyria, and put them in Halah and in Habor [by] the river of Gozan, and in the cities of the Medes: 12 Because they obeyed not the voice of the LORD their God, but transgressed his covenant, [and] all that Moses the servant of the LORD commanded, and would not hear [them], nor do [them]." In 18:10 it tells you how long the siege continues. Then into 18:11 it says what happens after those three years of siege. It says that the Assyrians took away Israel. And in 18:12 it tells you why; because they obeyed not the voice of the Lord their God. So, 2 Kings and Joel tell you what happens here (see boardwork 37:17) in the history where the ten tribes were destroyed.

Who's the king that we just read in 18:9? It is the seventh year of Hoshea. Here he is (see boardwork 40:57), Hoshea. But it also cross-references another king; it mentions Hezekiah. The reason I want us to see that is because in Isaiah 1:1 it says that Isaiah is going to minister in this history. *"The vision of Isaiah the son of Amoz, which he saw concerning Judah and Jerusalem in the days of Uzziah, Jotham, Ahaz, [and] Hezekiah, kings of Judah."* It mentions Hezekiah, Ahaz, Jotham, and Uzziah; four kings. So, you know Isaiah's ministry is from Uzziah to Hezekiah. And it is connected to the history of the final fall of the Northern tribes.

I want to put one more piece here for us. Go to Amos 1:1. *"The words of Amos, who was among the herdmen of Tekoa, which he saw concerning Israel in the days of Uzziah king of Judah, and in the days of Jeroboam the son of Joash king of Israel, two years before the earthquake."* What you will notice here is a bit more information. When is Amos ministering? In the days of Uzziah; so, he is marking the beginning. And who is ruling in the North? Jeroboam; he doesn't tell you, but this is the second Jeroboam of the Northern tribes. The first one was here at the beginning (see boardwork 45:39).

Why am I telling you all this information? Before I tell you, let's go to Hosea 1.1, where you will see the same information. *"The word of the LORD that came unto Hosea, the son of Beeri, in the days of Uzziah, Jotham, Ahaz, [and] Hezekiah, kings of Judah, and in the days of Jeroboam the son of Joash, king of Israel."* So, Hosea ministers for the same amount of time as Isaiah. It also mentions Jeroboam, as does Amos. Now, if you were to look at a chronology of all the kings, notice that there are four kings listed on the line of the Southern tribes (Uzziah, Jotham, Ahaz, and Hezekiah); and then count from Jeroboam to Hoshea, you will mark that there are seven kings from the Northern tribes. So, there is a relationship between these seven kings from the Northern tribes and these four kings from the Southern tribes. I want you to remember that, because we are going to draw truth from this relationship between seven and four.

Boardwork 45:39

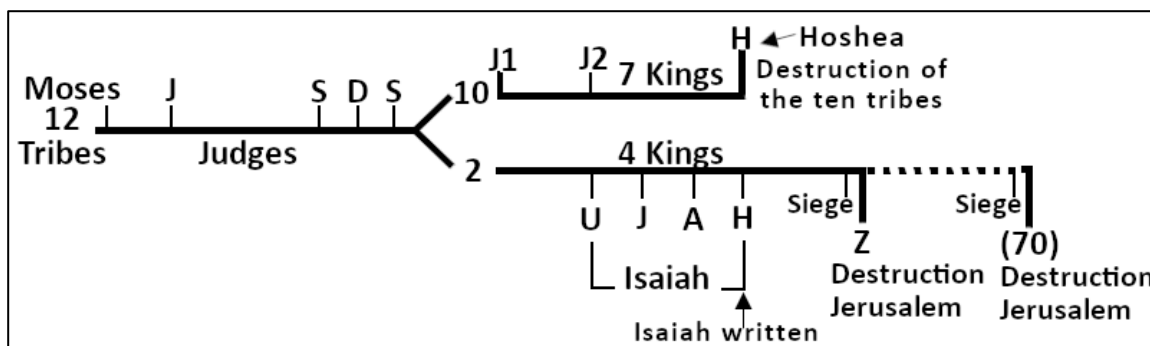

Let's go back to Isaiah. We will look at 46:9,10; but I want to give us some context first. First, we know that Isaiah is written in this history here (see boardwork 45:39); it's at the very end of his ministry, and just before the destruction of Jerusalem. When Jerusalem gets destroyed what happens to all the people? Where do they go? They get taken to Babylon, don't they? We know that. You could go to Leviticus 26; it would tell you. You could go to Daniel 1. You could go to Ezekiel 1. All these passages show you that God's people get taken to Babylon. We read it in Isaiah 6:13 already. So, Isaiah is predicting that God's people are going to be taken into the land of their captivity and Jerusalem is going to be destroyed. And what are

God's people currently doing? Isaiah 46:1. *"Bel boweth down, Nebo stoopeth, their idols were upon the beasts, and upon the cattle: your carriages [were] heavy loaden; [they are] a burden to the weary [beast]."* What's it talking about? This passage is talking about idolatry.

Now if you were to study 46:1-8, what you are going to see is that there are two gods that are going to be discussed. The God that is speaking to them (the True God) and these other gods (Bel, Nebo, etc.). And what God is going to do is compare Himself with those other gods. Isaiah 46:5 says this, *"To whom will ye liken me, and make [me] equal, and compare me, that we may be like?"* He says it three times: like, equal, compare. So, God is comparing Himself with these other gods. If you go through the passages, what is the difference between the two gods? What's the difference between those idols and the True God? Go to the second part of verse four. *"I have made you, I will bear you, I will carry you."* Who does the carrying? Who is carrying who? God is carrying the people. Let's go to 46:6. It basically says that they embellish these idols. They worship them. And then 46:7 tells you what they do to these gods. *"They bear him upon the shoulder, they carry him..."* So, who is carrying who? The people are carrying the gods. So, God says, *"What kind of foolishness is this?"* Would you serve a god that you have to carry around, or would you serve a God that carries you around?

Did God carry His people? When they were going through the wilderness, wondering for forty years did Jesus (or God) carry His people? Yes! What does the Bible say He carried them on? It says He carried them on the wings of an eagle. He protected them and shielded them. So, Isaiah in chapter 46 is here (see boardwork 45:39) near the end of his ministry, and he is comparing the True God with the false gods. Who is worshiping the false gods? It is not the Gentiles. It is His own people. Remember we read that in Ezekiel 8. God's people are committing idolatry. So, that is the context of this chapter.

Then God changes and says, *"I'm going to show you another way that I am different to these gods."* *"I carry you, and you have to carry them."* When God carries His people (I gave the example), it is the wilderness wondering that he is referring to. Now the reason why this is important... If you go to chapter 45, who does it speak of in 45:1? *"Thus saith the LORD to his anointed, to Cyrus, whose right hand I have holden, to subdue nations before him..."* Cyrus. Now we know that Cyrus is not in the story here in Isaiah's history. When does Cyrus come into the story? When does he begin to interact with God's people? We can show when he begins to do that. After the destruction, God's people get taken into captivity. So, we are here (see boardwork 56:07) at the destruction of Jerusalem during Zedekiah, and then there is captivity. So, this is the captivity in Babylon. And at the end of Babylon, Cyrus is going to come. Cyrus begins to reign at the end of the Babylonian captivity. He rules with his uncle, and his uncle's name is Darius.

Boardwork 56:07

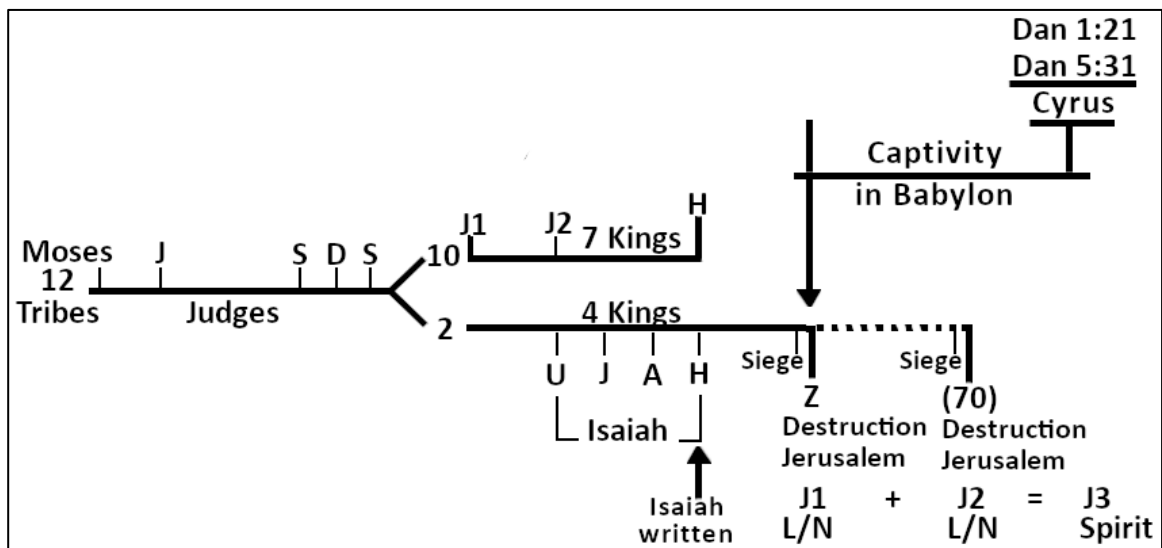

If you go to Daniel 5:31, it tells you the end of Babylon. *“And Darius the Median took the kingdom, [being] about threescore and two years old.”* Darius has become the king; Darius will rule for two years. At his death, Cyrus becomes the king. If you go to Daniel 1:21, it says it there. *“And Daniel continued [even] unto the first year of king Cyrus.”* So, that is where we mark Cyrus, at the end of the captivity.

Remember we said that we are supposed to go from the past to the present, and the present is a repeat of the past. We know the book of Revelation is not the past; it is the present; it is the end of the world. Go to Revelation 16. Remember, we are here with Cyrus. His uncle became king first, ruled for two years, and then Cyrus became the king. Let me put a piece of information in place. Keep your finger in Revelation 16 and go to Daniel 10:1. *“In the third year of Cyrus king of Persia a thing was revealed unto Daniel, whose name was called Belteshazzar; and the thing [was] true, but the time appointed [was] long: and he understood the thing, and had understanding of the vision.”* In Daniel 10 it says it is the third year of Cyrus, and in Daniel 1 it says it is the first year of Cyrus. So, there is a contradiction; and we know the Bible does not have contradictions, so we need to explain what the discrepancy is. They are the same year. In chapter one it's marking the first year when Cyrus is king by himself; because Darius has died. This would be the second year (see boardwork 58:53), and this would be the first. This would be one year, two years. This is Daniel 5:31, is when Darius became king. So, I will put Darius. When Darius ruled, this was also the first year of Cyrus. Two years on becomes the third year of Cyrus, which is also the first year of Cyrus. It is marking the first year of Cyrus in Daniel 1:21, *“And Daniel continued [even] unto the first year of king Cyrus.”* So, the third year of Cyrus is the first year of Cyrus; it's the same year. It is just two different ways of calculating. So, how many kings are there here during Darius' first year? There is Darius and Cyrus; two kings. That is the natural history.

Boardwork 58:53

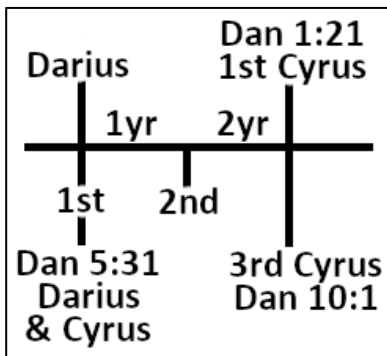

Do we all know how they destroyed Babylon? They go to the city; they can't break through the walls, but Babylon has the River Euphrates passing through it (see boardwork 1:01:29). It is there to supply the water; this is a huge river. So, what does Cyrus do? He makes a trench, creates a big reservoir, breaks the dam/wall between the river and the trench, and diverts the river into the reservoir. So, he dries up the river and they go underneath the wall. That is a well recorded piece of history.

Boardwork 1:01:29

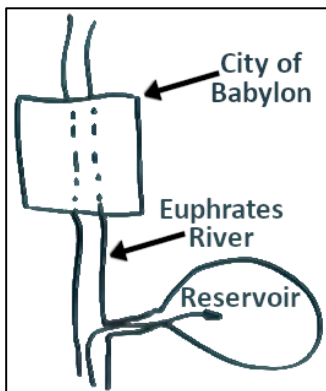

Let's go to Revelation 16:12. This shows us clearly this principle that history will repeat. *"And the sixth angel poured out his vial upon the great river Euphrates; and the water thereof was dried up, that the way of the kings of the east might be prepared."* It says the river Euphrates is going to be dried up like it was during Cyrus. And it tells you the purpose, that the kings of the east might be prepared. And where do Cyrus and Darius come from? They came from the East, and there are two kings. So, if you understand the history, you can make the prophetic application at the end of the world. People who do this carelessly (I could say foolishly), try to look to Israel, Iraq, Iran, and look for things happening in the country called Shinar. We know that Shinar means the country between two rivers (the river Tigris and the river Euphrates), which is where Iraq is at the moment. So, there are Evangelical Christians who don't understand how to deal with the 'Natural' and the 'Spiritual,' who are expecting a 'Natural' fulfilment of Revelation 16:12; and they are looking for something to happen literally in Iraq, or literally in Jerusalem. That's why Israel today receives such support from Evangelical Protestant America. Because the Americans believe, incorrectly, that the Jews are still God's people. And all that the Jews need to do is to accept the Messiah and they will be the 'First Fruits' or the 'Leading' people on this planet to usher in the second advent. Whereas we, as Adventist, we know that the Jews have no part in 'End Time' prophecy. They are not God's people. They are not going

to be leading out in any work. In fact, what they have to do is accept the Messiah and be baptized into the Seventh-day Adventist Church, just like every other person has to, in order to find acceptance into the Kingdom of Heaven.

It is these kinds of misunderstandings of not being able to deal with the 'Natural' and 'Spiritual' to not understanding how these two Persian kings (one a Mede, one a Persian) who came from the East, how they are supposed to be dealt with at the end of the world. But this is not going to be fulfilled in the Middle East. This is not related to the Jewish Nation in any way whatsoever. This is a 'Spiritual' worldwide phenomenon involving two kingdoms, kingdoms of this world and the Kingdom of Heaven. And the Kingdom of Heaven is the Seventh-day Adventist Church. The problem with God's Church is that it is steeped in apostasy, and that has to be eradicated. The way God will deal with that is the same way He has dealt with it in the past; God sends His prophets (His messengers) to plead with you to repent. And when you don't listen, He then turns to stronger measures; and it always results in the same thing, destruction (J1) and destruction (J2). And that is what is about to happen to God's Church. We are about to be destroyed; but each of us has the opportunity (if we repent of the sinful mindset that we have) to escape that destruction, because the remnant is always going to be saved.

When we start considering this present history (see boardwork 1:09:43) it has to be in terms of the 'Spiritual,' not the 'Literal' or 'Natural.' If people are teaching you things about Iraq, the 'Literal' river Euphrates, the 'Literal' Jewish Nation, that this is what is being referred to in these passages, they have a wrong understanding of Bible prophecy. It's not that the Middle East is not involved in 'End Time' prophecy, because it is; but they have a different role, and it has to be understood in a 'Spiritual' context.

Boardwork 1:09:43

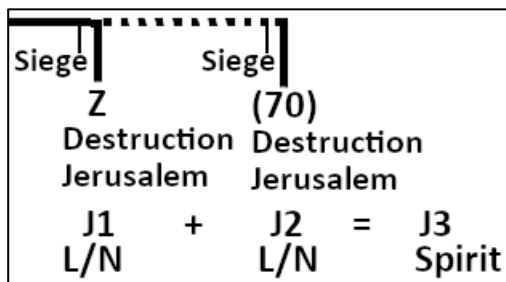

Let me summarize. The 'Seal of God' is closely connected to the Sabbath; we saw that in Ezekiel chapters 8 and 9. I also led you to Spirit of Prophecy passages that indicated that. The 'Mark of the Beast' is the opposite of the 'Seal' or the 'Sign' or the 'Mark' of God, just as Sunday is the opposite of Sabbath. We've seen how the captivity that follows the destruction here (see boardwork 1:11:39), where Nebuchadnezzar destroys Jerusalem is going to be used to develop an argument by God to prove to you who the true God is whether you believe in God's messengers or cunningly devised fables (in error). We also saw (because this is the ministry of Isaiah) that it is in the history of four kings that Isaiah does his ministry, as does Hosea; and we also marked Amos. And we saw that it's four kings in Judah and seven kings in Manasseh (Ephraim). The relationship between the four and the seven becomes important for us to understand; and we need to understand the 'Natural' or the 'Literal.' We understand that there were two kings that came from the East; they dried up a real river to enter into a real city. But at the end of the world our focus is not that they are

going to build this great city in Iraq and two people from the Middle East are going to come and destroy that city; neither are the Jewish 'Literal' people involved in 'End Time' prophecy, except in the sense that they need to be saved like everyone else does.

Boardwork 1:11:39

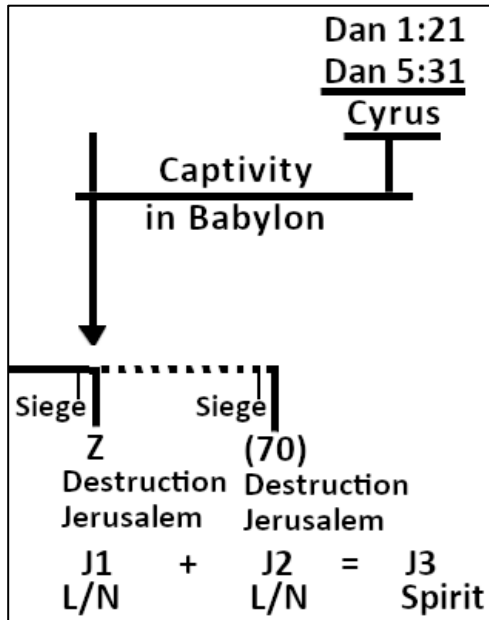

Let's pray. Heavenly Father, to thee we give thanks for your watch care and your goodness towards us. We ask for a blessing in Jesus' name. Amen.