



Brazil SOTP

Revolutions 4

Tess Lambert

4/03/19



Escola dos Profetas - O Livrinho



1

1

We're going to take a minute and review the sea of Cilicia and Pamphylia because it is a recurring theme.

We identify the midnight cry or Panium. This is the defeat of the King of the South, the deadly wound leading up to the death. Then we identify this waymark as Sunday law. But if we want to call this the midnight cry then what does SL become? Close of probation, which means we have a shut door. From the midnight cry to the shut door we have the fall of the United States or of Adventism. We have the rise of the UN and a new type of leadership in the Adventist Church. We come to this way mark we mark the end of the sixth head in the beginning of the seventh. This is the sea of Cilicia and Pamphylia . If this is a close of probation and we bring this history into our history, the line of the priest, what are these waymarks? Panium becomes 2018 and COP becomes Raphia. From 2018 to Raphia what do we expect to see externally?

To start with the external, we said in our last class regarding the United States that it's marking stages in its life cycle. We can say 2016 there's a dictator that's raised up and the Republican horn is broken. We can say the same thing at Raphia, we can say the same thing Panium and we can say the same thing at SL. The reason we said that, because when we go to these histories we see the death and the rising up of a dictator. So on this side of the line we have Abraham Lincoln and on the other side we can mark Napoleon. On one side Kaiser Wilhelm and the other side Lenin. So you can mark the death and the rise of a dictator but it's the same person. And you can see the sixth and seventh head is the same country, the United States and then the United States now wielding power over the UN. There is also this element of a change in leadership. We can see Adventism in this history, once it comes to the history of the midnight cry in the ship you hear the voice of Paul, and Ellen White says whether it looks like it or not he's the master of that ship. So we're seeing this external and internal. There's a change in leadership and stages of its life cycle. We look at the external and we see Donald Trump. He's already been a leader but he starts to transform and he becomes the leader after SL that he wasn't back in the prior history. He has a new type of authority.

Acts 27:1-5

Sea of Cilicia and Pamphylia

2018
Raphia

Panium
MC
SL
COP

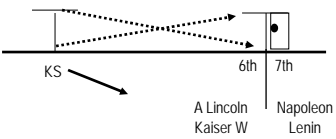

2016
2019
Panium
SL

dictator
dictator
dictator
Dictator Over UN

2

2

Acts 27:1-5
Sea of Cilicia and Pamphylia

This is the fall of their institutions so the United States is falling, as a lamb like beast or Republicanism. What we're doing is marking progression. It can represent different people. We can see Obama turn to Trump. So there's times when it represents different people but one person can represent two people. So we bring this into the internal, 2018 to Raphia, what are we supposed to see? Elder Jeff announced his resignation, whatever that means. But he's passing the mantle. We're seeing this transition between our midnight cry and our close of probation.

The movement all the way through, before and after. But there's a transition in leadership. Whether we mark it between midnight cry and close of probation or Panium and Sunday law we see this change. We can take this model and take it to 2018 and it's something that's progressive, it doesn't all happen at once. But you see a change. Externally in the United States we can already see Trump's language since December of 2018, it's changed. For those first two years he had advisors who restrained him.

3

3

Acts 27:1-5
Sea of Cilicia and Pamphylia

Now he doesn't take advice unless it comes through Fox news like he did on December 19th. But we bring it to the internal and we're already seeing a transition in leadership. It's moving between Elder Jeff and Elder Parminder. We can mark it already happening right before Raphia. People are getting concerned because they think Elder Jeff is going to die. Why would they think that? They may try to make the connection with Abraham Lincoln. It's the same principle but they're looking at some different people. They would say Moses and they name some names, Elijah went to heaven and Moses died. Therefore they say that Elder Jeff is going to be taken from us. I would say that's a misapplication of history and prophecy because it doesn't mark a death but a transition. I don't think that it's marking something bad is going to happen Elder Jeff, **all it's marking is a change, a transition in the life cycle of this movement just the same as we mark a life cycle in the United States.**

Clarification on the external of Raphia: At Raphia we mark a dictator in the United States. So there's a transition from one type of leadership to another type of leadership. It's a progressive work and you can mark it at 2012. When is Paul the master of the ship? Long before it's obvious. In 2012 to 2016 we parallel internal and external. It's Trump before and it's Trump after. It's also Elder Parminder before and elder Parminder after. The process began years ago but it's a process of time, progressive.

We went into the histories of revolutions and we want to address people's fears about what that looks like. Because to fear that evil will happen to Elder Jeff is also making the same mistakes with history just because Moses died.

4

4

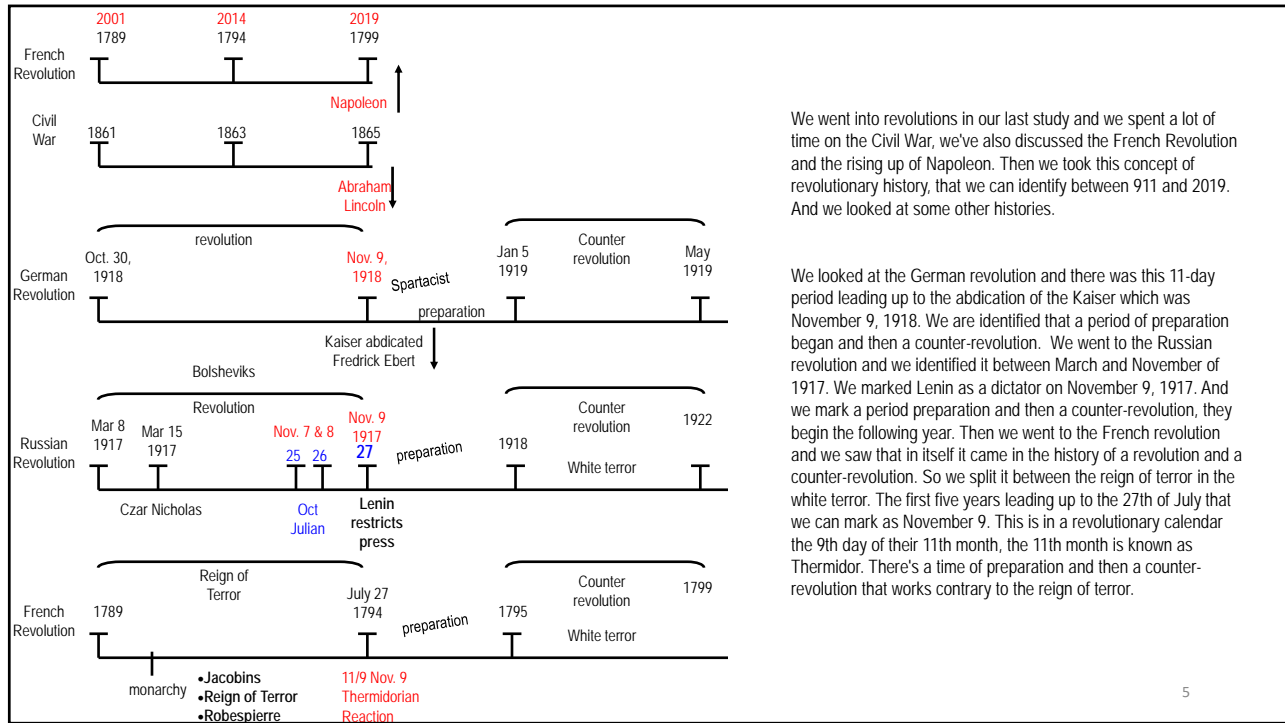

We went into revolutions in our last study and we spent a lot of time on the Civil War, we've also discussed the French Revolution and the rising up of Napoleon. Then we took this concept of revolutionary history, that we can identify between 1789 and 2019. And we looked at some other histories.

We looked at the German revolution and there was this 11-day period leading up to the abdication of the Kaiser which was November 9, 1918. We are identified that a period of preparation began and then a counter-revolution. We went to the Russian revolution and we identified it between March and November of 1917. We marked Lenin as a dictator on November 9, 1917. And we mark a period preparation and then a counter-revolution, they begin the following year. Then we went to the French revolution and we saw that in itself it came in the history of a revolution and a counter-revolution. So we split it between the reign of terror in the white terror. The first five years leading up to the 27th of July that we can mark as November 9. This is in a revolutionary calendar the 9th day of their 11th month, the 11th month is known as Thermidor. There's a time of preparation and then a counter-revolution that works contrary to the reign of terror.

5

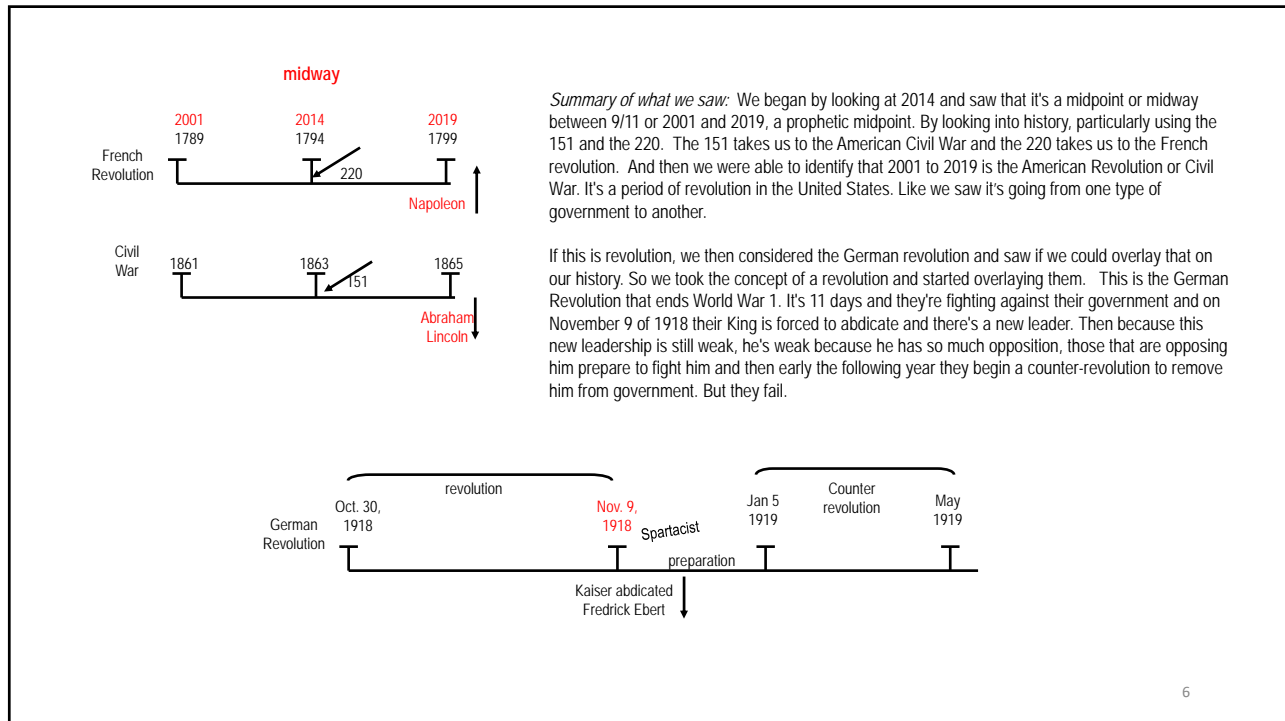

Summary of what we saw: We began by looking at 2014 and saw that it's a midpoint or midway between 1789 or 2011 and 2019, a prophetic midpoint. By looking into history, particularly using the 151 and the 220. The 151 takes us to the American Civil War and the 220 takes us to the French revolution. And then we were able to identify that 2001 to 2019 is the American Revolution or Civil War. It's a period of revolution in the United States. Like we saw it's going from one type of government to another.

If this is revolution, we then considered the German revolution and saw if we could overlay that on our history. So we took the concept of a revolution and started overlaying them. This is the German Revolution that ends World War 1. It's 11 days and they're fighting against their government and on November 9 of 1918 their King is forced to abdicate and there's a new leader. Then because this new leadership is still weak, he's weak because he has so much opposition, those that are opposing him prepare to fight him and then early the following year they begin a counter-revolution to remove him from government. But they fail.

6

1

French Revolution

2001 1789 11/9 2016 2014 1794 2019 1799

Napoleon

2

French Revolution

1789 1794 1795 1799

monarchy •Jacobins •Reign of Terror •Robespierre

July 27 1794 preparation

11/9 Nov. 9 Thermidorian Reaction

Counter revolution 1795 White terror

In the history of the French revolution, we've already applied the French revolution in a first application and this is our second application in the same histories.

We've split this into two periods of five years but when we actually go in closer to look at that revolution it also comes in these two parts that we've observed above. The first five years is the monarchy being overthrown by the Jacobins and Robespierre. This is the reign of terror where they kill a lot of people. This period ends on the 27th of July which in their calendar is the 9th day of their 11th month, they made their own calendar and their version of November 9 is the day that Robespierre and this faction is overthrown. All those opposed to him, to the Jacobins took time to prepare before they tried to wipe out the Jacobins in France. So there are some differences with this one compared to Russian and German revolutions. But this is the Jacobins persecuting the monarchy and those wealthy classes. In this counter revolution the same people the Jacobins were persecuting, fight back and they try to remove the Jacobins from France.

7

7

What were marking as a pattern is this middle column. The beginning dates do not give us information, at least combined at this stage of our understanding, as far as time is concerned neither do the endpoints. But it's this middle column.

French Revolution 2001 1789 2014 1794 2019 1799

Civil War 1861 1863 1865

German Revolution Oct. 30, 1918 revolution Nov. 9, 1918 Spartacist preparation Jan 5, 1919 Counter revolution May 1919

Russian Revolution Mar 8, 1917 Mar 15, 1917 Revolution Nov. 7 & 8, 1917 Nov. 9, 1917 preparation 1918 Counter revolution 1922

White terror

French Revolution 1789 1794 1795 1799

monarchy •Jacobins •Reign of Terror •Robespierre

July 27 1794 preparation

11/9 Nov. 9 Thermidorian Reaction

Counter revolution 1795 White terror

8

8

We also had Robert Blum and that was a November 9th on 1848 and this is a separate revolution. As we read symbolically his death ended the revolution. When this leader's executed it shows that the revolution against the government is futile.

November 9, 1848, how do we want to apply that and why? We apply it to 2016 as a turning point where our position would be futile at the election of Donald Trump November 9, 2016. Once they reject Hillary Clinton all hope of stopping this revolution is futile. In that sense we can mark the Republican horn broken because it's progressive, but after 2016 inevitable. There was another reason to place it in 2016 from Millerite history. It was two years before the loud cry. So when we make it 2016 if we compare the internal in the external it's 2 years before a loud cry. So by looking at the revolution the fact that it didn't end there and by seeing it as an internal Millerite waymark, we can see that it's not their closed door the same way it doesn't end the revolution. It exists in the history of the Russian revolution 2 years before a loud cry. Or 2016 but you can still mark on November 9. This is the November 9 in history that would take us to Donald Trump's election.

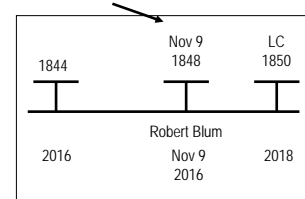

So this middle column takes us to the end of a revolution. We can connect the 9th of November, the 9th day of the 11th month. Following that there's a time period of preparation where the enemies combine forces to fight against what he set up here (middle column, Nov. 9). Then early the following year his counter-revolution begins which we're marking as 2020 and that fails. We should also note that is an election year.

We need to look into why this is known as white terror in two different histories. Whether or not we want to take white as a symbol or whether or not we consider the division of race that is happening. It's something we need to think about.

White Terror

[First White Terror](#) (1794–1795), a movement against the French Revolution
[Second White Terror](#) (1815), a movement against the French Revolution
[White Terror \(Russia\)](#), mass violence carried out by opponents of the Soviet government during the Russian Revolution of 1917 and the Russian Civil War (1918–20)
[White Terror \(Bulgaria\)](#), the suppression of the Communist September insurgency in the Kingdom of Bulgaria (1923)
[White Terror \(Hungary\)](#), a two-year period (1919–1921) of repressive violence by counter-revolutionary soldiers
[White Terror \(Spain\)](#), assassinations committed by the Nationalist movement during the Spanish Civil War and Francisco Franco's rule
[White Terror \(mainland China\)](#), the period of political repression in China starting in 1927 by the Republic of China/Kuomintang government
[White Terror \(Taiwan\)](#), the period of political repression in Taiwan starting in the 1940s by the Republic of China/Kuomintang government
[White Terror \(Greece\)](#), persecution of the EAM-ELAS between the Treaty of Varkiza in February 1945 and the beginning of the Greek Civil War in March 1946
[White Terror \(Finland\)](#), violence of the White troops during and after the Finnish Civil War in 1918

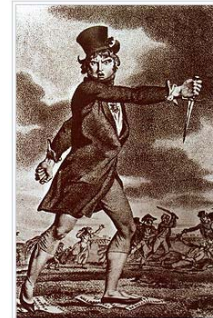

Picture by an unknown artist showing a member of the 'Compagnons du Soleil', who carried out White Terror attacks in southeastern France

The **White Terror** was a period during the [French Revolution](#) in 1795, when a wave of violent attacks swept across much of France.^{[[citation needed](#)]} The victims of this violence were people identified as being associated with the [Reign of Terror](#) – followers of [Robespierre](#) and [Marat](#), and members of local [Jacobin clubs](#). The violence was perpetrated primarily by those whose relatives or associates had been victims of the Great Terror, or whose lives and livelihoods had been threatened by the government and its supporters before the [Thermidorean Reaction](#). Principally these were, in Paris, the [Muscadins](#), and in the countryside, monarchists, supporters of the [Girondins](#), those who opposed the [Civil Constitution of the Clergy](#) and those otherwise hostile to the Jacobin political agenda.^[1] The Great Terror had been largely an organised political programme, based on laws such as the [Law of 22 Prairial](#), and enacted through official institutions such as the [Revolutionary Tribunal](#), but the White Terror was essentially a series of uncoordinated attacks by local activists who shared common perspectives but no central organisation.^[2] In particular locations, there were however more organised counter-revolutionary movements such as the [Companions of Jehu](#) in [Lyon](#) and the [Companions of the Sun](#) in [Provence](#). The name 'White Terror' derives from the white cockades worn in the hats of royalists

11

11

The **White Terror** in [Russia](#) refers to the organized violence and mass killings carried out by the [White Army](#) during the [Russian Civil War](#) (1917–23). It began after the [Bolsheviks](#) seized power in November 1917, and continued until the defeat of the White Army at the hands of the [Red Army](#). The White Army fought the Red Army for power, which engaged in its own [Red Terror](#). According to some Russian historians, the White Terror was a series of premeditated actions directed by their leaders,^{[1][2][3]} although this view is contested by others. Estimates for those killed in the White Terror vary, from between 20,000 and 100,000 people^[4] as well as much higher estimates of 300,000 deaths.^[5]



Execution of the members of the Alexandrovo-Gaysky Regional Soviet by Cossacks under the command of Ataman Alexander Dutov, 1918.

The White Army

The [Volunteer Army](#) in South Russia became the most prominent and the largest of the various and disparate White forces.^[1] Starting off as a small and well-organized military in January 1918, the Volunteer Army soon grew. The [Kuban Cossacks](#) joined the White Army and conscription of both peasants and Cossacks began. In late February 1918, 4,000 soldiers under the command of General [Aleksi Kaledin](#) were forced to retreat from [Rostov-on-Don](#) due to the advance of the Red Army. In what became known as the [Ice March](#), they traveled to [Kuban](#) in order to unite with the [Kuban Cossacks](#) (most of whom did not support the Volunteer Army) In March, 3,000 men under the command of General [Viktor Pokrovsky](#) joined the Volunteer Army, increasing its membership to 6,000, and by June to 9,000. In 1919 the [Don Cossacks](#) joined the Army. In that year, between May and October, the Volunteer Army grew from 64,000 to 150,000 soldiers and was better supplied than its Red counterpart.^[2] The White Army's rank-and-file comprised active anti-Bolsheviks, such as Cossacks, nobles, and peasants, as conscripts and as volunteers.

12

12

Without assenting to this strong representation of the increasing strength and stability of slavery, without denouncing what of untruth pervades it, I own myself not insensible to the many difficulties and discouragements, that beset us on every hand. They fling their broad and gloomy shadows across the pathway of every thoughtful colored man in this country. For one, I see them clearly, and feel them sadly. With an earnest, aching heart, I have long looked for the realization of the hope of my people. **Standing, as it were, barefoot, and treading upon the sharp and flinty rocks of the present, and looking out upon the boundless sea of the future, I have sought, in my humble way, to penetrate the intervening mists and clouds, and, perchance, to descry, in the dim and shadowy distance, the white flag of freedom, the precise speck of time at which the cruel bondage of my people should end, and the long entombed millions rise from the foul grave of slavery and death.** But of that time I can know nothing, and you can know nothing. All is uncertain at that point. One thing, however, is certain: slaveholders are in earnest, and mean to cling to their slaves as long as they can, and to the bitter end. They show no sign of a wish to quit their iron grasp upon the sable throats of their victims. Their motto is, "a firmer hold and a tighter grip" for every new effort that is made to break their cruel power. The case is one of life or death with them, and they will give up only when they must do that or do worse.

<https://teachingamericanhistory.org/library/document/speech-on-the-dred-scott-decision-2/>

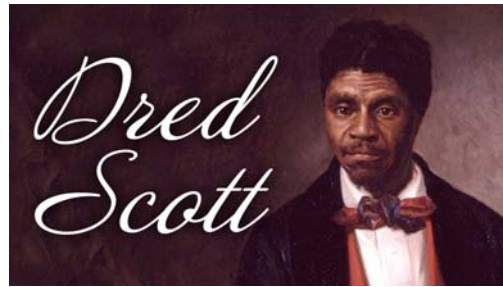

13

13

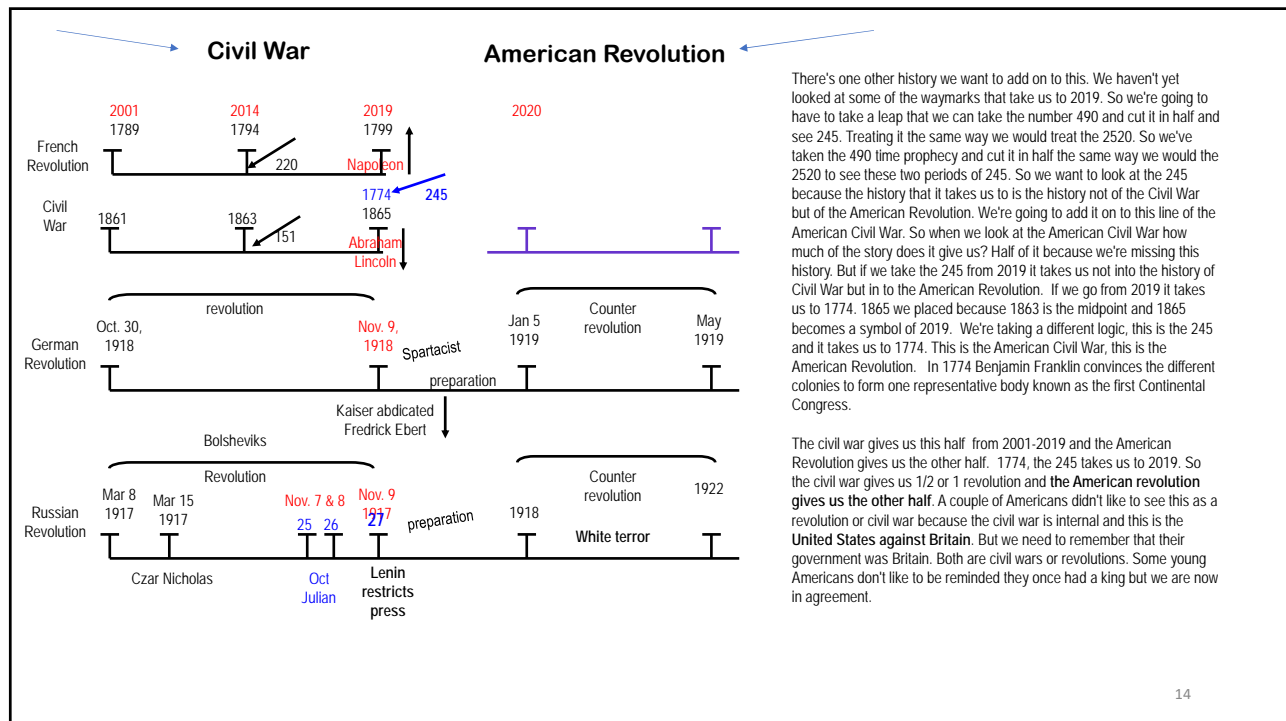

14

14

2

In 1774 they set up the first representative body of the colonies known as the first Continental Congress. This is the seed of where the American government begins. The French Revolution, second application, Nov. 9 is the seed of where it ends. Then you have a period of preparation, and what happens in 1775? Revolution breaks out between Britain and the states, but it's internal. If we use the 245 it doesn't take us to the beginning but to the middle column and it fills in our picture because it shows the period of preparation and then this revolution. It takes us from 2019 to where the revolution begins in 2020. When we come to this history we want to look at 2020. We did mention this in our earlier classes and we've only got a couple of classes left.

15

15

We're discussing the American Revolution now and we've already done this, we just want to look again at it. The reform line of the 144,000, we'll fill in the waymarks. Where do we start the reform line? 1989, the time of the end. Where do we go next? 911. The next waymark for the hundred 144,000 is the Sunday law and the close of probation and then the second Advent. There's just one waymark we want to put between these, one waymark missing what would that be? The loud cry.

Now the line of the priests, we begin at 1989 with the time of the end because 144,000 covers this whole history. Then we see that this line can be divided into fractals and the group that goes first are the priests so there must be someone raised up at the time of the end to begin studying prophecy. Next we go to 2001 and then 2014 and then 2019 our close of probation and then Panium or the second Advent for the priests. So we have 1989 to Panium.

16

16

144,000

Priests

Levites

Nethanims

Now we'll lay out the line of the Levites, where is there time of the end? 911 the first way mark. Then you have 2014 then you have Raphia 2019, and Panium is their shut door and Sunday law as their second coming.

Next the Nethinims, where is there time of the end? 2014, 2019, Panium, Sunday law and their closed door. Going through the agricultural model 2014 to 2019 the plowing for the Nethanims, early rain 2019 to Panium, latter rain Panium to SL, then harvest at SL—COP.

Harvest for the 144,000 on their line is after close of probation (Dan. 12:1) before second Advent but for the Nethanims their harvest is Sunday law to the close of probation.

The reason we wanted to review this is what brought us to the history of Pyrrhus? We went from Acts 27 to Pyrrhus, what took us there? 273 and where do we put that? Between Panium and Sunday law we mark the 273.

17

17

If we went back to the line of the priests and over laid Millerite history what waymark are we missing? August 1st. Where do we put that on the line of the priests? 2016 and we call that Concord. We see Boston, Concord and Exeter. So now we have waymark between 2014 and 2018. We've already discussed at camp meeting did that they come down and impact the line of the nethinims. What are they for the nethinims? 2016 and 2018 but on the reform line what would we name them? Increase of knowledge and a formalization of the message. So we can see that for the nethinims or the world there's been an increase of knowledge in the formalization just like we had from 1989 to 9/11. An increase of knowledge and a formalization. Now we can identify two way marks in these histories. For the Levites 911 to 2014 we have to have two-way marks. What the first one is still under discussion what's the second one? 2012 the prediction of 2014. Then we have these waymarks—Boston, Concord, Exeter, and they have to impact the Levites and the nethinims.

144,000

Priests

Levites

Nethanims

18

18

Then we discussed the history of the hundred 144,000, close of probation and the second Advent. We said in this history they must also have this increase of knowledge and formalization. The priests have it at the beginning of their journey and they have it at the end of their journey right before harvest so we must then see the same for the Levites and for the nethinims. What we begin to see is that these two waymarks of Concord and Exeter occur in every history, and in every dispensation. So between 2019 and Panium we have two waymarks because this is Boston Concord and Exeter for the Levites. So 2016 is Concord and we saw evidence of Concord, we saw it in two external institutions and we see a battle where the King of the North and the King of the South are in unity for Concord, the battle of Ipsus. Then we went to the history of the second Advent on the line of the 144,000. The first is the death decree and the second is a message of time. In this first one all of God's enemies are in concord or unity when they agree on this death decree. In every dispensation we have two waymarks and in these two waymarks they're connected by a thread. The first or Concord has the same characteristics. The second or Exeter has the same characteristics. When we bring it into the Levite's history we've seen Concord and Exeter, and we have two waymarks in the nethinim history between Panium and Sunday law.

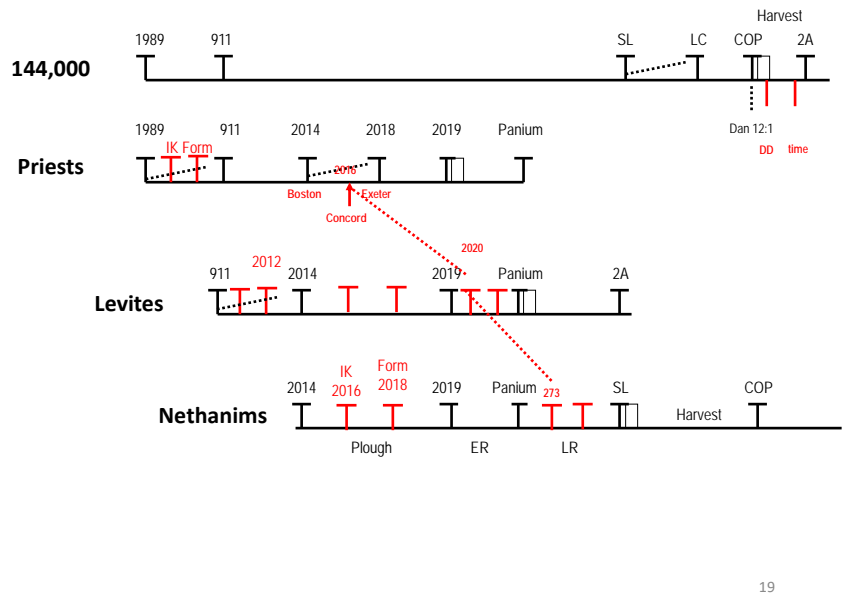

First is the 273 then we come up to the Levite history and it's the same connecting thread. This 273 and this Concord and we come into this first waymark. We're saying it's the same waymark we just drew up, 2020 the beginning of counter-revolution. There's two characteristics at the beginning of that revolution. Where is the first battle that begins that revolution? It's known as the Battle of Concord and Lexington. How many British casualties? 273. So we see this stitching together of our way marks. On the line of the priests, this is the waymark of Concord at 2016. We see its characteristics repeated in 2020, both are election years. But we have 2016 Concord and whatever date this is 273 that we got from acts 27 and 2020 on the Levite line stitches them both together. As we move forward along our reform line we need to have more light not just in these major waymarks but the characteristics that bind together these two smaller ones.

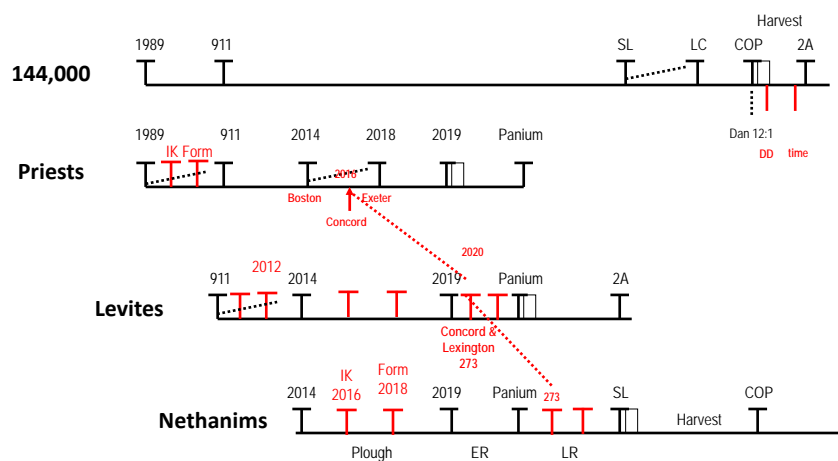

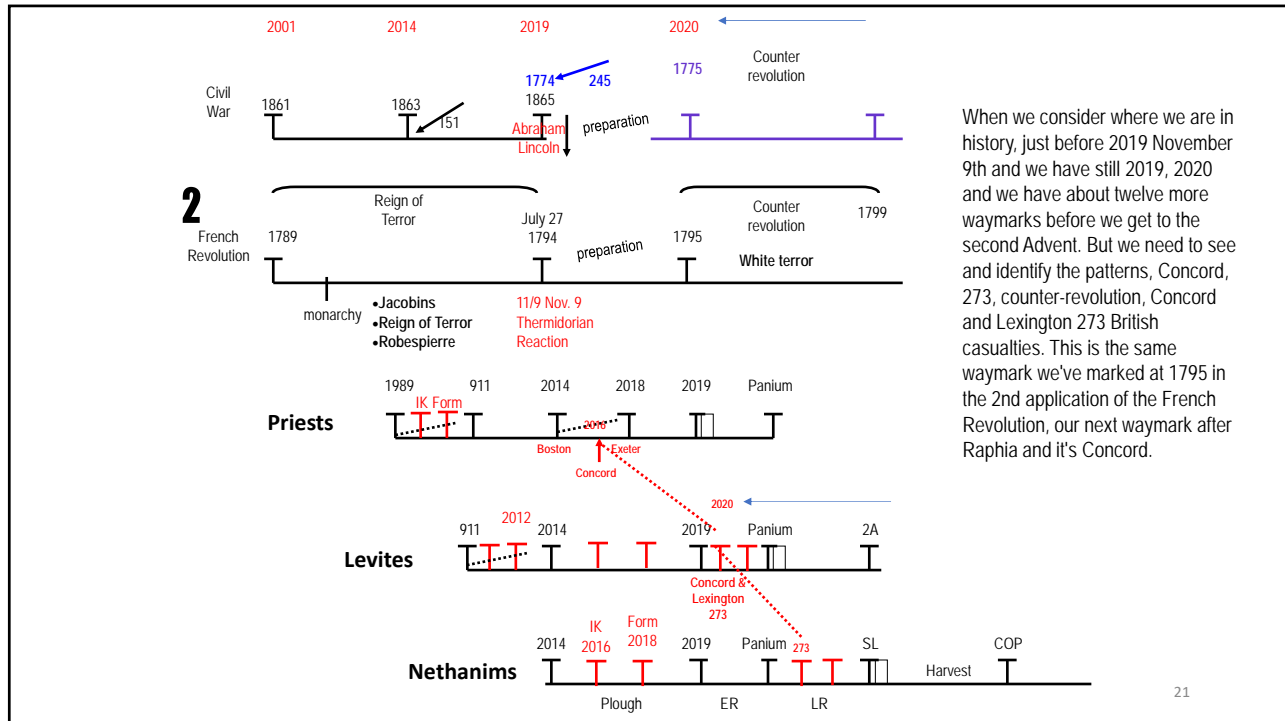

When we consider where we are in history, just before 2019 November 9th and we have still 2019, 2020 and we have about twelve more waymarks before we get to the second Advent. But we need to see and identify the patterns, Concord, 273, counter-revolution, Concord and Lexington 273 British casualties. This is the same waymark we've marked at the 1795 in the 2nd application of the French Revolution, our next waymark after Raphia and it's Concord.

21

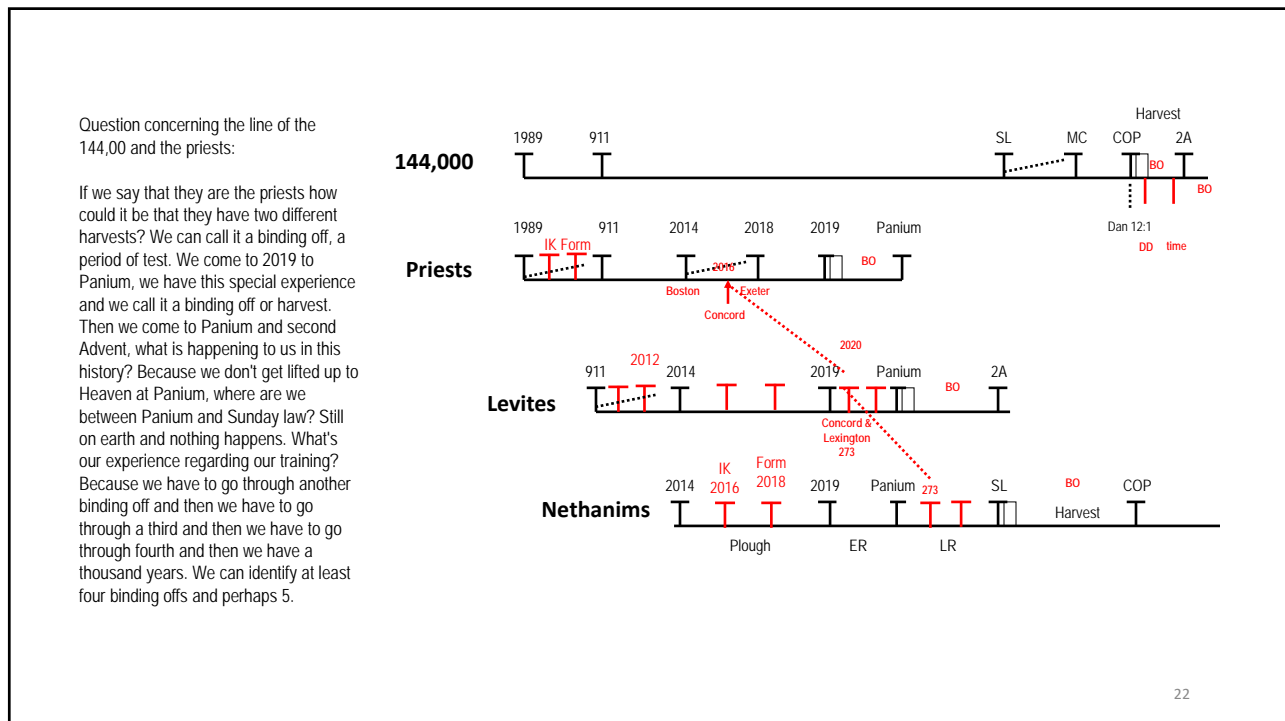

22

Question: How do the other binding offs have an impact on us?

We can see this history from 1989 to Panium as just one history of priests, but if you're willing to accept that the priests are the 144,000 and that is you, and you get raised up to Heaven at the final second Advent, why are you qualified to be of the 144,000? What makes you qualified? It isn't just a few years you've had in the movement prior to Nov. 9, 2019 to mean that you can go to Heaven and Moses and Elijah have to sit at your feet and learn from you. Because they don't get to be of the 144,000. All those other people, the Millerites, the Protestants, they have to learn from you, what makes you qualified? Experience, because you have to go through each experience and Elder Parminder has been teaching when we talk about the many that are overthrown at Sunday law they aren't Adventists. They are already in captivity. They are people in this movement that go through binding off, binding off and fall at Sunday law, we can still do that, or at close of probation. So for people in this movement, we're trained and tested if we are to be in the 144,000 all through this history. So that when we get to Heaven we're qualified to do the work of the 144,000. In the time of 2019 or Raphia to Panium, people are expecting terrible persecution and this terrible time of trouble, we're not saying it's going to be easy but we're still babies and we have much more training to do.

23

23

Question: I still don't understand how there can be a closed door November 9, 2019 and other closed doors going forward...

We'll put it this way, can you fail 2014 in make it? Can you fail 2019 and make it? No, if you fail that test you don't make it. That's a shut door but you can make it through that door, does that mean you could come to Panium and you're definitely going to make it through that test? We have to continue our training.

Question: but if the door is closed that means that you're sealed? Does it?

You're sealed for that test and we don't stop training and we don't stop being tested. It's not a test if we can't fail it. But if we make it through 2019 we're on the right side of the issue and much more setup to pass the following tests. But we're going to have to keep being trained if we're going to do the work of the 144,000.

24

24

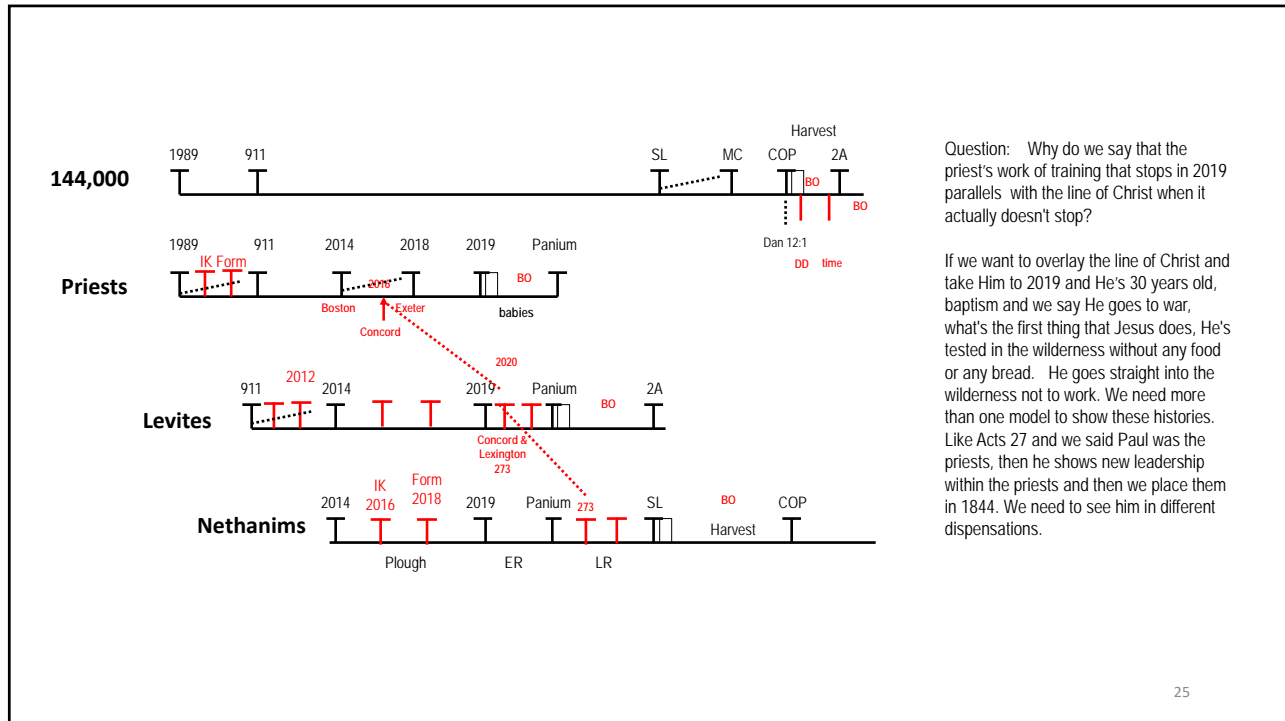

Question: Why do we say that the priest's work of training that stops in 2019 parallels with the line of Christ when it actually doesn't stop?

If we want to overlay the line of Christ and take Him to 2019 and He's 30 years old, baptism and we say He goes to war, what's the first thing that Jesus does, He's tested in the wilderness without any food or any bread. He goes straight into the wilderness not to work. We need more than one model to show these histories. Like Acts 27 and we said Paul was the priests, then he shows new leadership within the priests and then we place them in 1844. We need to see him in different dispensations.

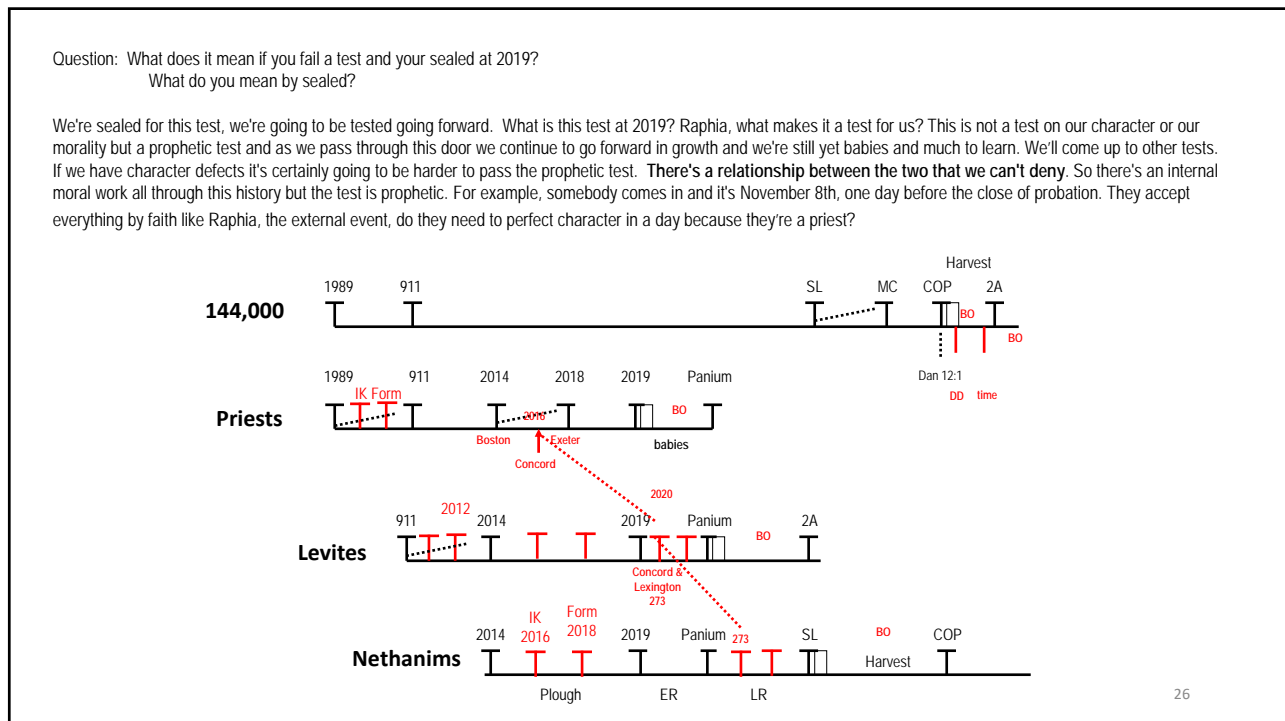

Can a priest have sin in their life after 2019 and still be forgiven?

Can we have sin in our life after 9/11 and baptism? If we bring that to the model we can't have sin after 9/11. If we want to talk about whether or not we have an Advocate, we have one in this history and we also have one of this history because we're tested prophetically. Is Jesus going to stop doing his work just for a few people for the person that came in on November 8th? No. The closed-door means if you fail this prophetic test at Raphia, your cut down, you will never rejoin this movement, so the door is shut. But we're just beginning our journey because God isn't doing all this work to raise up priests or even Levites or Nethinims, he's got all of these people going to Heaven, people from areas that never heard of Jesus that will wake up in that morning having no idea what's going on. They go to Heaven and meet Jesus and they don't know who He is and they're going to be looking for their drums, there music, for their meat. **The role of the 144,000 is as a teacher which means we have a lot of training to go through to be able to go to Heaven and teach.**

And what kind of training do we receive? Our experiences

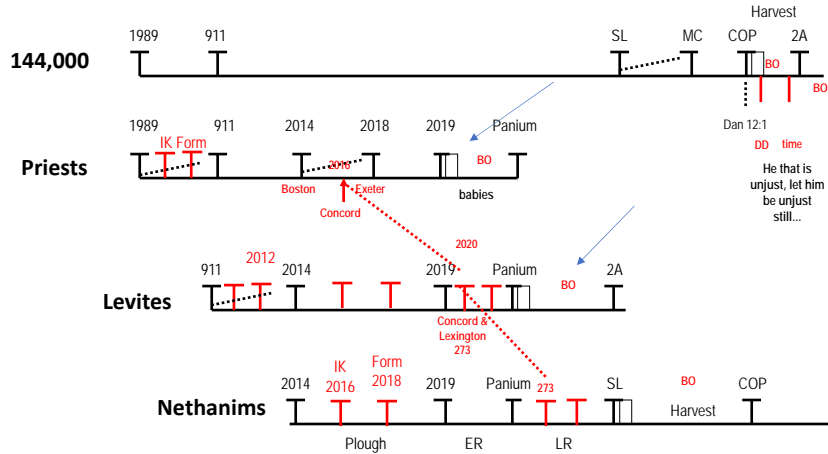

27

27

Question: Can you pass 2019 with known sin because people are talking about Raphia as the closed door, also as a moral or your character test, people talk about being prepared and having a perfect character to pass 2019.

If we have known sin, in what condition are we in? Lost or saved? If we're not putting away sin then are we even on this reform line? That's a work that gets done in this history. If we start bringing sin into the model we're going to have problems.

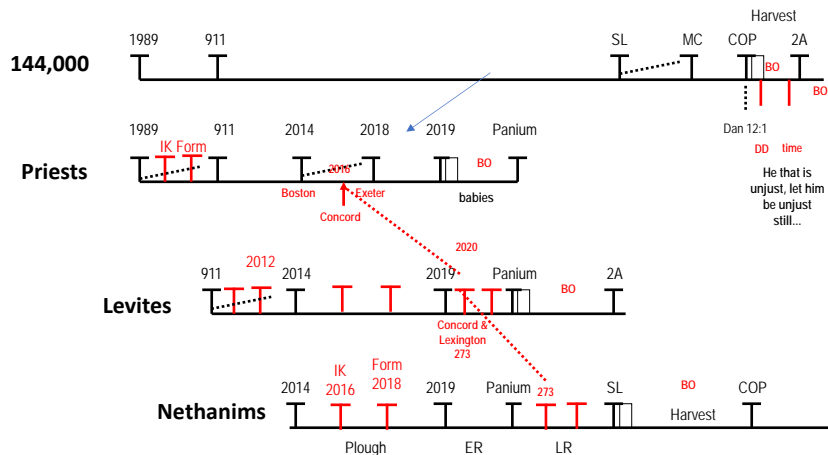

28

28

Question: When I looked at 1844 there was the close of probation, I think it was not a moral test because the way Ellen White describes this event and those people, they were doing all the reforms and being caring with each other, and in the moral sense they were being perfect I think. What Ellen White describes was the problem is that they didn't get the message and they couldn't accept the message and they failed. I think it's the same case in 2019, if you don't get the message you'll fail the test, and it's not a moral test.

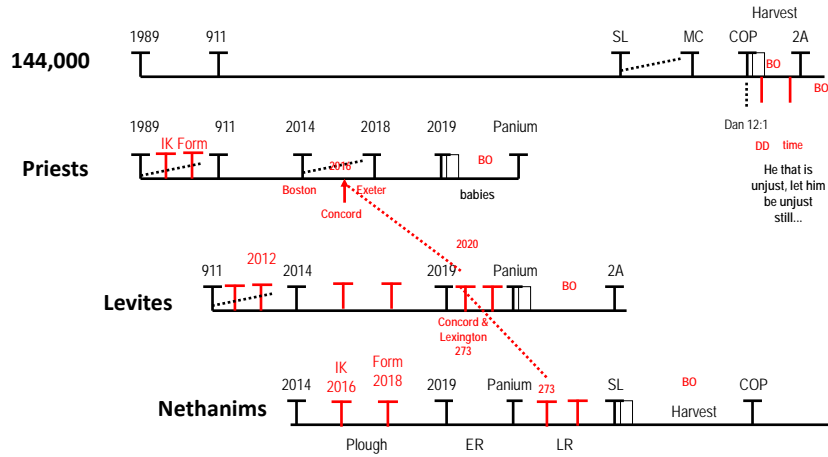

29

The line of the Millerites — close of probation October 22 1844, it's a shut door, people pass people fail. If you're willing to agree with Elder Parminder's classes that Jesus really could have come back in 1863, then we also understand there's a second call in 1850. We have to start considering fractals in that line. If we say that October 22nd is a moral test and they're sealed then we should expect all the Millerites that passed October 22 made it through that history, not one fell away. I don't think history agrees with that. October 22nd was a shut door because they fell away and they could still fall away afterwards.



30

30

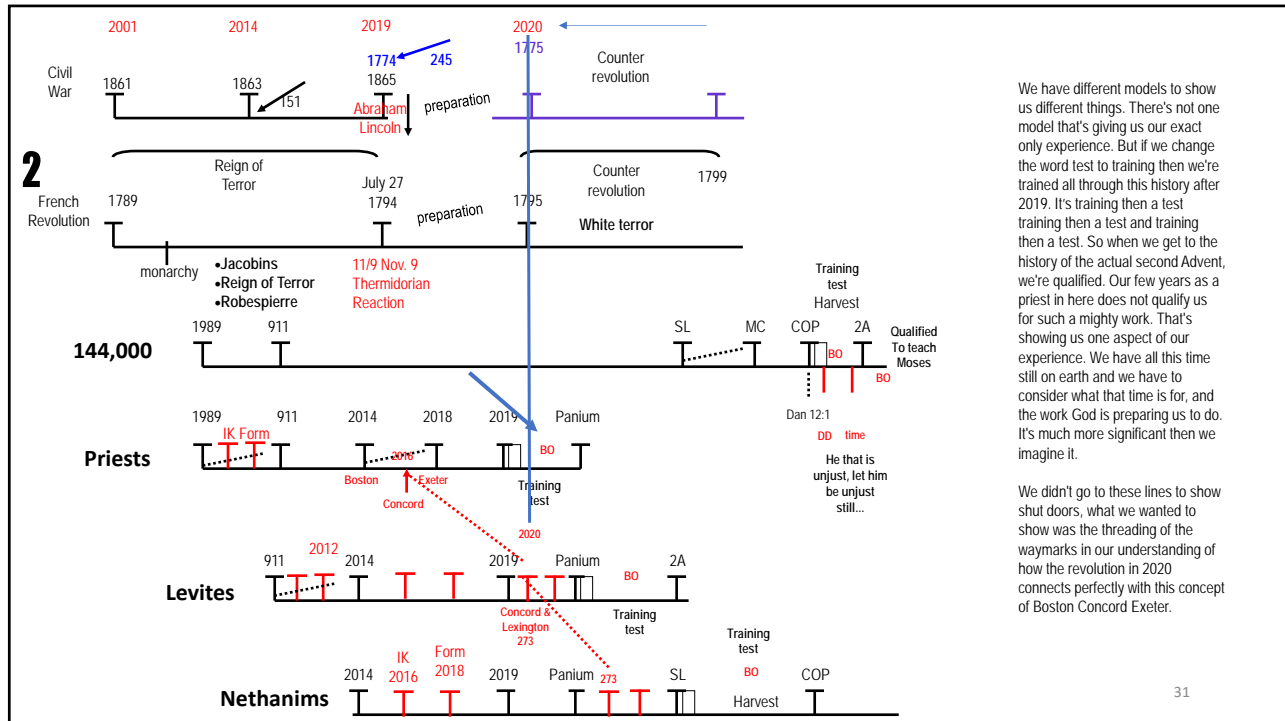

We have different models to show us different things. There's not one model that's giving us our exact only experience. But if we change the word test to training then we're trained all through this history after 2019. It's training then a test training then a test and training then a test. So when we get to the history of the actual second Advent, we're qualified. Our few years as a priest in here does not qualify us for such a mighty work. That's showing us one aspect of our experience. We have all this time still on earth and we have to consider what that time is for, and the work God is preparing us to do. It's much more significant then we imagine it.

We didn't go to these lines to show shut doors, what we wanted to show was the threading of the waymarks in our understanding of how the revolution in 2020 connects perfectly with this concept of Boston Concord Exeter.